





UNE-T DESK/TABLE

 NOTE: These instructions are based on model #UNE-T7142-ADJ. These instructions work for all UNET desk & table models. Product images are for illustrative purposes only and may differ from actual product.

 The assembly of this desk requires the assistance of another person.

TOOLS NEEDED





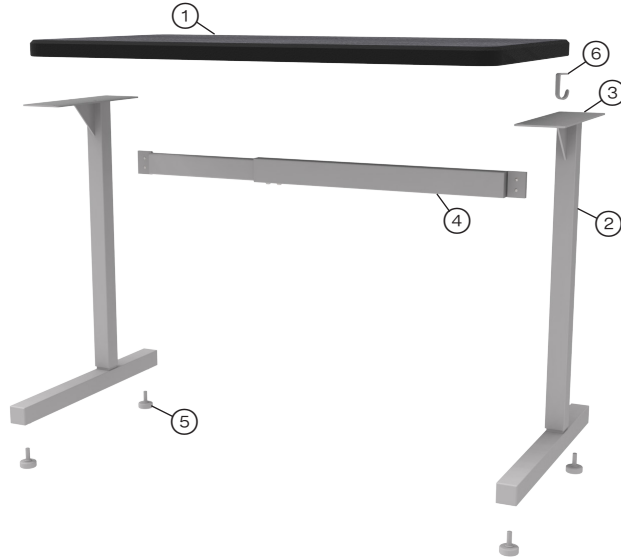

PARTS

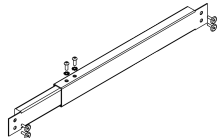

PARTS x QTY

#	DESCRIPTION x QTY
1	Laminate Top x 1
2	Leg x 2
3	Leg Plate x 2 (Attached to Leg)
4	Cross Bar x 1
5	Footing x 4
6	Backpack Hook x 1 (Optional)

HARDWARE x QTY

 1/4"-20x19mm joint connector bolts x 6 per leg plate 04088861	 UNE-T connector bar (adj. or non-adjustable) 04009770 (27"L top size) fixed bar 04009771 (36"L top size) fixed bar 04009772-G4 (48"L top size) fixed bar 04009773 (54"L top size) fixed bar 04077747-G4 (27", 30" & 36"L top sizes) adj. bar 04066970 (27"-44" top size) adj. bar 04066939 (38"-66" top size) adj. bar
 M6-1x10mm button head socket screw x 4 (Used to attach non-adj cross bar) 04067356	
 M6-1x14mm button head socket screw x 2 0401259 (Used to attach adj cross bar)	
 #12 star lock washer 0404281	 1.38" nylon glide NSL-33056

PARTS

OPTIONAL HARDWARE x QTY

 <p>2.5" Grand Hank nylon glide, 3/8"-16x1" x 1 per leg 040164</p>  <p>1.5" soft touch glide x 1 per leg 04067920</p>	 <p>Backpack hook x 1 04066852 (black) 04066852-G4 (smooth silver)</p>  <p>1/4"-20x19mm joint connector bolt x 1 04088861</p>
 <p>1.25" steel glide x 1 per leg NSL-33056S</p>  <p>Dual wheel soft tread locking caster x 1 per leg 04067540</p>	 <p>Metal wire management x 1 04009316 (36"L) 04009242 (48"L) 04009241 (60"L) 0400350 (72"L)</p>  <p>#8x3/4" screws x 10 0404248</p>
 <p>UNE-T foot rest x 1 04066605</p>	 <p>2 3/8"D black grommet w/ cover x 1 - 48"L top or x 2 - 60" & 72"L tops 0406659</p>



NOTE: Hardware packs are included in packaging. You may receive more hardware than needed. Discard any extra hardware after assembly.



CAUTION! Some parts may have sharp edges. Care must be taken when handling various pieces to avoid injury. For your safety, wear a pair of work gloves when assembling.

ASSEMBLY

1. Place top ① face down on protected flat surface so that the threaded inserts are facing up.
2. Align leg plates ③ (attached to legs ②) with threaded inserts in the top ①.

Using a 4mm Allen wrench or 4mm hex bit, secure top with 1/4"-20x19mm joint connector bolts. **DO NOT FULLY TIGHTEN** until Step 6.

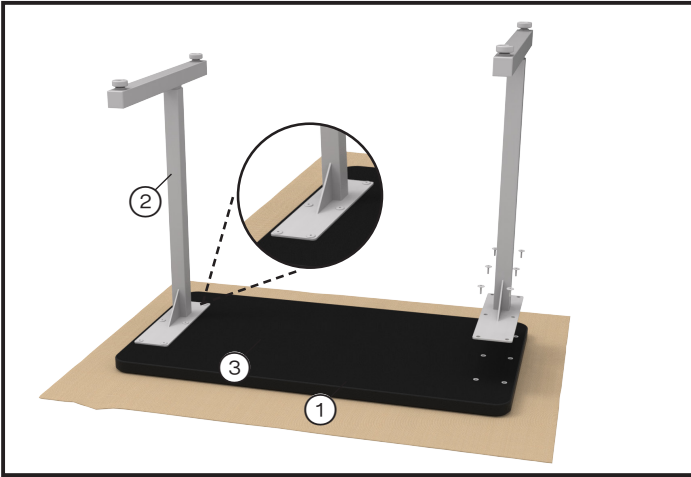

3. Remove the #12 star lock washers and M6-1x10mm screws located in the legs ②.

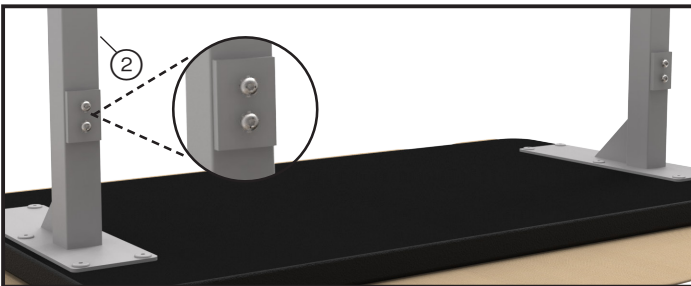

Align holes in cross bar ④ with pilot holes in legs ②. Attach using #12 star lock washers and M6-1x10mm screws. The bar should rest inside the legs. **DO NOT FULLY TIGHTEN** until Step 6.

If you have an adjustable cross bar, use #12 star lock washers and M6-1x14mm screws to fasten the two connector bars together. **DO NOT FULLY TIGHTEN** until Step 6.

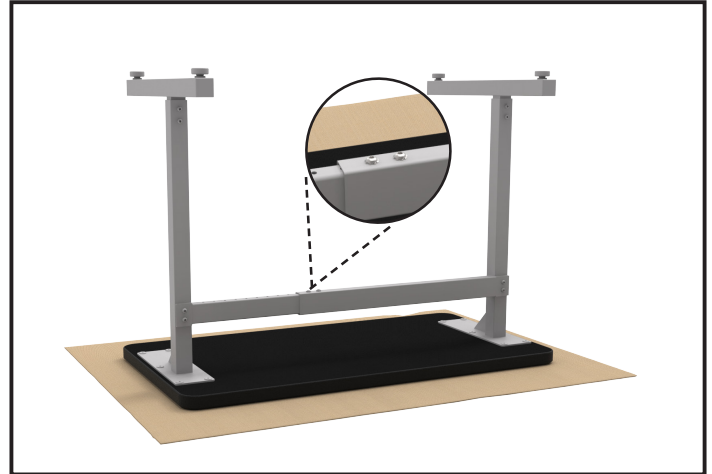

4. If assembling a desk or table with a foot rest bar, repeat Step 3 with the foot rest bar on the lower portion of the legs.
5. If assembling a table/workstation with metal wire management, align pre-drilled holes in metal wire management with pilot holes in the top. Attach wire management to top using #8x3/4" screws and a Phillips screwdriver. Fasten down tightly.
6. Fully tighten legs ②, connector bar ④ & foot rest (if foot rest was ordered) with fasteners. Adjust leg height and glides as needed.
7. If assembling a table/workstation with grommet(s), insert grommet(s) into the pre-determined location in the top.
8. If optional footing was ordered, remove nylon glide ⑤ from leg by rotating it counterclockwise until glide is free. Place stem of optional footing into the hole on the leg. Rotate clockwise until fully inserted into leg. Tighten with a 14mm open-ended wrench (for dual wheel caster only). Repeat for each caster/glide.

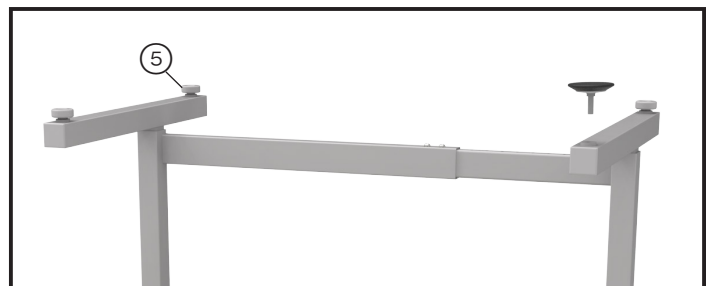

ASSEMBLY

12. If a backpack hook was ordered, determine the location in which you would like to place the optional backpack hook ⑥. Remove the joint connector bolt from the leg plate ③ in the determined location.

Align tab of the backpack hook on top of the leg plate.

Using a 4mm Allen wrench or 4mm hex bit, secure backpack hook to the leg plate ③ with a 1/4"-20x19mm joint connector bolt.

